

[®]
MEGALITE

FOLLOWBOT Compact 1000w LED

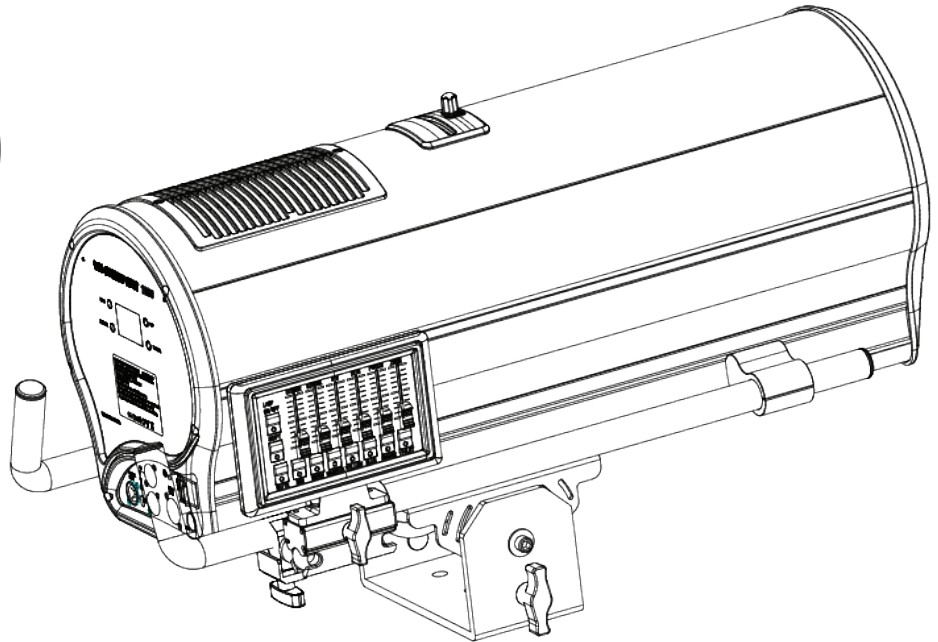

USER MANUAL

Table of Contents

Safety Information	2
What's Included	2
Specifications	3
Main Power Connection	4
DMX Connection	4
Controller Connection	5
Controller Operations	5
Colors	6
Gobo Holder	6
Display Settings	7
DMX Profile	9
Size And Weight	10
Cleaning	10
Installation	10
Parts & Accessories	10
Warranty	11
Customer Service	12



Read all cautions and warnings
prior to operation of this
equipment

Protection Against Fire



1. Maintain a minimum of 2 foot distance from any type of flame.
2. Fixture is not designed for outdoor use.
3. Do not install the unit too close to a heat source.
4. Make sure cables are properly secured.
5. Maximum surface operating temperature: 130°.

Protection Against Electrical Fire

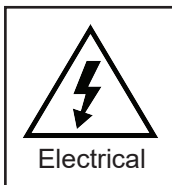

1. Disconnect power before servicing.
2. For connection to main power supply, proceed to page 4.
3. The power supply must be earthed (electronically grounded).
4. This fixture must not be left on for long periods of time.

Protection Against Mechanical Hazards

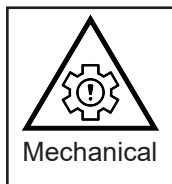

1. Use quality clamps or bolts when positioning unit.
2. Do not open unit while it is on. Risk of electrical shock.
3. Use secondary safety attachment to secure Fixture to Stand
4. Note: Fixture will home on power up, causing noise to come from the fixture.

What is Included

1pc Followbot Compact 1000w LED fixture
1pc Follow Spot Stand = P-Stand2
1pc Seetronics SAC3FCA Connection to
Nema 5-15 Connection Cable
1pc Gobo Holder
1pc User Manual

Specifications

Part Number

Fixture ID

7070- FOLLOWBOT COMPACT 1000W LED

Mechanical Specifications

Housing:	Extruded Aluminum & Plastic Bezel
Mounting System:	Weight Distribution Yoke and Follow Spot Stand (w/ ball bearing pan)
Power Connection:	Seetronics SAC3MPA Input (Nema 5-15 to SAC3FCA cable included)
Signal Connection:	5 Pin XLR In and Out
Color Wheel:	7 colors
CTO:	3 Set CTO Filters Open: 8537 K CTO 1 6391 K CTO 2 5336 K CTO 3 3343 K
Focus:	Electronic Focus
Zoom:	Beam Angle 3° to Field Angle 13° Electronic Zoom
Iris:	Electronic Iris
Static Gobo:	1 Removable Gobo Slot (non rotational)
Strobe:	Strobe Control (Only on DMX Control Mode)
Filters:	Accessory Boomerang Available
Weight:	63 lb
Size:	32" X 13.25" X 16.25"

Electrical Specifications

Light Source:	1 X 1000W LED
Lumens @ Full:	Wide: 29310 Lm Narrow: 31741 Lm
Display:	LCD
Power Supply:	Electronic 100-240V AC 50/60
Power Consumption:	1249 Watts 10.7 Amps @110V PF: 0.99

Control & Programming

Protocol:	DMX 512
DMX Mode:	8 Channel Mode Dimmer, Strobe, Iris, Color, CTO, Zoom, Focus, Diffusion
Manual Mode:	Hand Rail Mounted Scene Recorder Controller (included)

Main Power Connection

Caution!

1. Do not connect to a dimmer system.
2. Connection points must not be exposed to moisture or liquids. Use appropriate connections rated for indoor use.
3. This unit has auto switching power supply. It will respond to 100-240V AC 50/60Hz automatically
4. Replace Fuse with specific type and rating. 110V use 15A / 220V use 8A
5. This unit must be earthed. (electronically grounded)

Cable USA	Cable EU	110V	220V
Black	Brown	Live	Live
White	Light Blue	Neutral	Live
Green	Yellow / Green	Ground	Ground

DMX-512 Connection

The fixture is equipped with 5 pin XLR Sockets for DMX input and output connection. The sockets are wired in parallel. Only use a shielded twisted pair cable designed for RS-485 and 5 pin XLR plugs and connectors in order to connect the controller with the fixture or the fixture with another.

DMX - Input

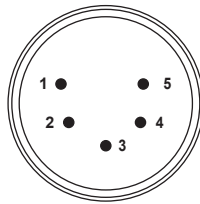

1.Shield (Grd)
2. Signal (-)
3. Signal (+)
N/A
N/A

DMX - Output

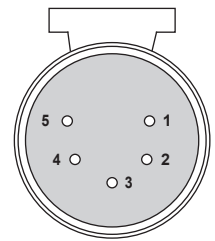

Caution!

On the last fixture the DMX signal needs to be terminated with a terminator. Pre-manufactured terminator are available for purchase from your Mega-Lite dealer item #P-DMX-T.

Rail Controller Connection

When using the Followbot Compact 1000W Led with Rail Mounted Controller the following cable configuration must be followed. (do not connect DMX Console to this connection as this may cause damage).

Controller Connection

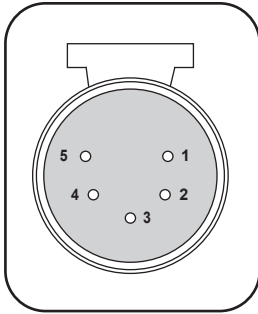

XLR Position	Cable Color	Connection
Position 1	Red	Ground
Position 2	Green	DMX -
Position 3	Blue	DMX +
Position 4	Not Used	N/A
Position 5	Black	12v DC +

Rail Mounted Controller Operation

Note: (Lamp On function must be engaged in conjunction with dimmer for Lamp to come on)

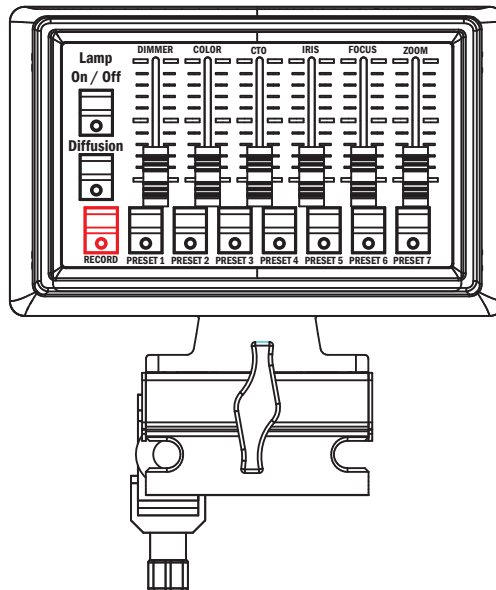







Addressing the Fixture: Fixture needs to be set to DMX Start address 001 and Rail Controller needs to be plugged in to the 5 pin connection labeled **Controller Connection**. (note: you can't connect DMX Console signal and Controller signal at the same time, DMX Signal will take precedence)

Record Function: Press the red record button. Make sure the lamp is on, adjust the faders control to reflect the scene you would like to record. Press the preset button 1-7 you would like to record. Presets maybe recorded over by repeating the the same process over and existing recorded button





Playback Function: Turn off the record Button. Press the preset 1-7 button to select the pre recorded preset.

Colors

Color Wheel

	Red
	Green
	Magenta
	Yellow
	Blue
	Orange
	Purple

CTO Wheel

	Open	8537K CTO
		6391K CTO
		5336K CTO
		3343K CTO

Gobo Holder

Gobo Size
39.5mm
Image Size
23.5 mm
Max Thickness
2 mm

- Warning!**
1. Gobo Holder must be inserted with **B** side facing the Back and **F** side facing the Front
 2. Gobo Size 39.8mm outer diameter 23.5mm image size, max thickness 2mm
 3. Gobo should be placed between gobo ring trim and spring holder.
 4. Glass Gobo reflective coating should face the lamp source, black coating should face output lens.

Danger!
Gobo Holder will be hot once it has been used. Let fixture cool



Display Settings

The control board on the fixture is your interface to access and control all the functions on the unit. It's LCD display gives you a code view of the options and functions of the fixture. The following will explain each function and it's options.

ESC

Enter



Up

Down

<ul style="list-style-type: none"> Main Menu Fixture Address Information Personality Test Program Main - Remote Manual Mode 	<p>--Set Address--</p> <h1>001</h1>	<p>Fixture Address: Press Enter to select the fixtures DMX Start Channel. Use the Up/Down button to select desired start channel. Start Channel must match Consoles DMX Start Channel.</p> <p>Note: if using Rail Mounted Controller set DMX Start Channel to 001</p>
---------------------------------------------------------------------------------------------------------------------------------------------------------------------------------------------------------	-------------------------------------	-----------------------------------------------------------------------------------------------------------------------------------------------------------------------------------------------------------------------------------------------------------------------------------------------------------

<ul style="list-style-type: none"> Main Menu Fixture Address Information Personality Test Program Main - Remote Manual Mode 	<p>-Fixture info-</p> <ul style="list-style-type: none"> Power On Time Lamp Temperature Version:1.0 	<p>Information: Press Enter to Select Function</p> <p>Power On Time: Will give you the amount of hours the fixture has been on for. The Clock can be reset by resetting the timer.</p> <p>Lamp Temp: Information displayed is the LED lamp area temperature reading. Do not operate with temperature exceeding 60°C</p> <p>Version: Operating Software Version</p>
---------------------------------------------------------------------------------------------------------------------------------------------------------------------------------------------------------	---------------------------------------------------------------------------------------------------------------------------------------------	-------------------------------------------------------------------------------------------------------------------------------------------------------------------------------------------------------------------------------------------------------------------------------------------------------------------------------------------------------------------------------------------------------

<ul style="list-style-type: none"> Main Menu Fixture Address Information Personality Test Program Main - Remote Manual Mode 	<p>-Personality-</p> <ul style="list-style-type: none"> Display Adjust Iris Reverse Color Presetting Shut Presetting System Reset 	<p>Personality: Allows for fixture preference setting</p> <p>Display Adjust: Invert Display On or Off Select Language: English or Chinese</p> <p>Iris Reverse: Invert Iris Operation On or Off</p> <p>Color Presetting: Turn On or Off the use of the Color Wheel</p> <p>Strobe Set: Turn On or Off the use of the Strobe function on DMX Controlled Mode</p> <p>System Reset: Reset all motor and electrical functions</p>
---------------------------------------------------------------------------------------------------------------------------------------------------------------------------------------------------------	---------------------------------------------------------------------------------------------------------------------------------------------------------------------------------------------	-----------------------------------------------------------------------------------------------------------------------------------------------------------------------------------------------------------------------------------------------------------------------------------------------------------------------------------------------------------------------------------------------------------------------------------------------------------------------------------------------------

Main Menu
Fixture Address
Information
Personality
Test Program
Main - Remote
Manual Mode

-Test Program-
On
Off

Test Program:

Press the Enter button to select fixture to run all internal functions for test purpose select on off .

Main Menu
Fixture Address
Information
Personality
Test Program
Main - Remote
Manual Mode

-Main / Remote-
Remote
Main

Main / Remote:

In **Remote** mode the fixture will work as an independent fixture and will not send DMX signal via output. In **Main** Mode the fixtures Rail Mounted Controller will work as the master controller and will send DMX commands out via DMX Output connection. Additional Fixtures will require a DMX Signal Connection and to be set to DMX Address Channel 001.

Main Menu
Fixture Address
Information
Personality
Test Program
Main - Remote
Manual Mode

-Manual Mode-
Dimmer
Strobe
Iris
Color
CTO
Zoom
Focus
Frost

Manual Mode:

Press the Enter button mechanical and electrical functions of the fixture will now be able to be used via display settings

DMX Profile

Followbot Compact 1000W LED				
DMX Channel	Function	Description	Value	Init
1	Dimmer	Dimmer Off to Full	0-255	255
		No Function	0-1	
		Strobe (slow to fast)	2-127	
2	Strobe	Pulse (slow to fast)	128-159	0
		Reverse Pulse (slow to fast)	160-191	
		Random (slow to fast)	192-255	
3	Iris	Iris (Open to Close)	0-255	0
		Open	0-31	
		Red	32-63	
		Green	64-95	
4	Color	Yellow	96-127	0
		Blue	128-159	
		Orange	160-191	
		Purple	192-223	
		Aqua	224-255	
		Open	0-63	
5	CTO	63K CTO	64-127	0
		52K CTO	128-191	
		33K CTO	192-255	
6	Zoom	Zoom	0-255	255
7	Focus	Focus	0-255	46
8	Diffusion	No Function	0-15	0
		Diffusion Engage	16-255	

Size and Weight

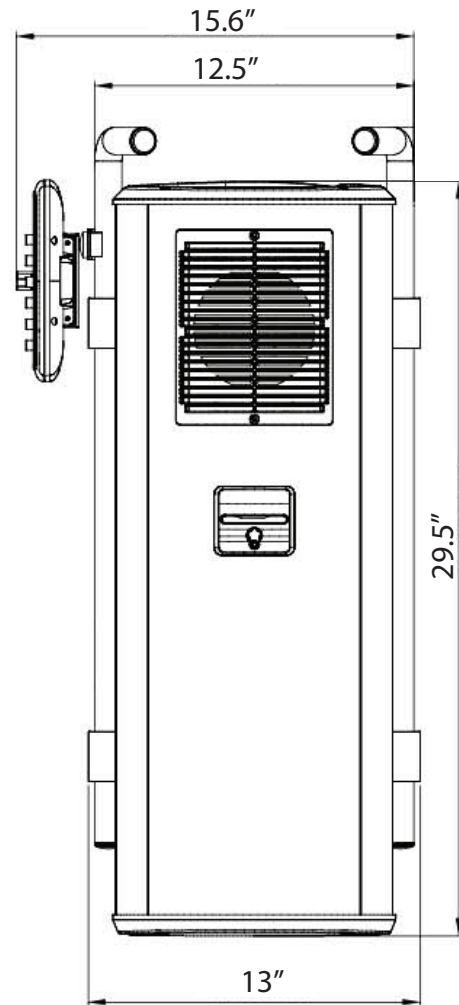
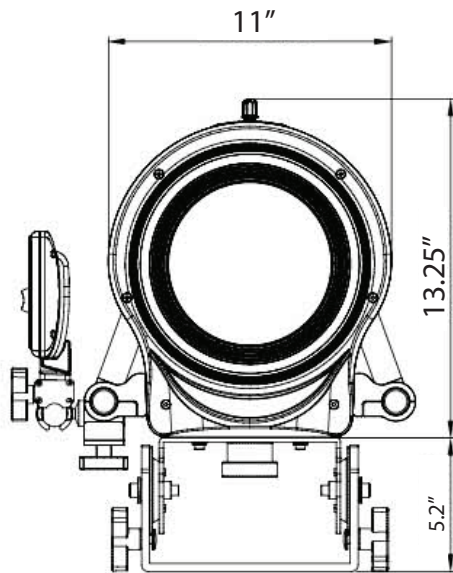
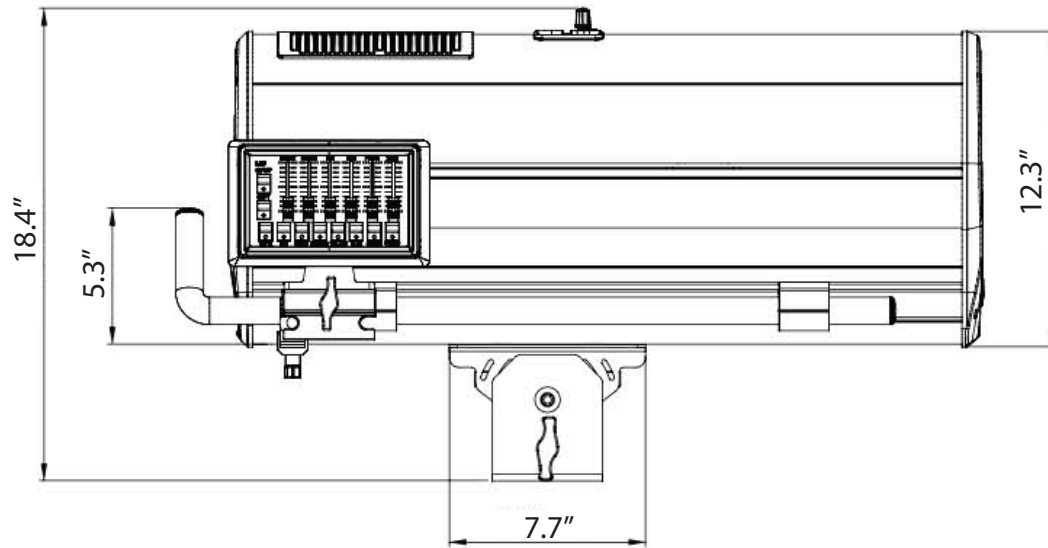

Fixture Size:	32" X 13.25" X 16.25"
Fixture Weight:	63 lb
Packaged Size:	38" X 18.5" X 22.5"
Packaged Weight:	66 lb

Installation

Caution!

1. The Installation must be carried out by an authorized dealer or trained professional.
2. Unit may cause severe injuries, if you have doubts concerning the safety do not install.
3. Unit is to be 24 inches away from flammable materials.
4. Use high quality installation equipment to place the unit.

When placing the it is very important that you follow common safety procedures. Installation requires extensive experience including but not limited to calculating working weight loads, material being used and periodic safety inspections. If you lack these qualifications, do not attempt the installation yourself, instead use a professional structural rigger.

When placing the unit always be secure with a secondary safety attachment.

Cleaning and Maintenance

Installation Maintenance- The operator has to make sure that the unit is operating safely and has the installations and electronics checked by an expert every year.

The following points must be considered during the inspection:

- 1) All screws used for installing the device or part of the device have to be tightly connected and must not be corroded.
- 2) There must not be any deformations on the housing, fixation and installation spots (ceiling, suspension, trussing).
- 3) The electronic power supply cables must not show any damages, material fatigue (e.g. porous cables) or sediments. Further instructions depending on the installation spot and usage have to be adhered by a skilled installer and any safety problems have to be removed.
- 4) Fixture housing must only be cleaned from the outside using only soap and water.

Note: Maintenance and service operations are to be carried out by authorized dealers.

Replacing the fuse: When possible, only replace the fuse with the same type and rating.

Replacing the power cable: If the power cable of this device becomes damaged, it has to be replaced by authorized dealers or trained professionals only.

Should you have further questions, please contact your dealer.

Parts & Accessories

PARTS	
ITEM #	DESCRIPTION
7070-POW-LAR	LARGE POWER SUPPLY
7070-POW-LAR-SMA	SMALL POWER SUPPLY
7070-PCB-DIS	DISPLAY PCB
7070-PCB-DRI-MOT	MOTOR DRIVER PCB
7070-PCB-SEN	MOTOR SENSOR PCB
7049-PCB-CON	CONTROLLER
7070-PCB-DRI-LED	LED DRIVER PCB
7070-LED	REPLACEMENT LED

ACCESSORIES	
ITEM #	DESCRIPTION
P-STAND-2	BLACK FS STAND (INCLUDED)
7070-GOB	GOBO HOLDER (INCLUDED)
7070-CON	HAND RAIL CONTROLLER (INCLUDED)
CAS-7070-1-B	ROAD CASE
7049-BOOM	BOOMERANG

GENERAL TERMS AND CONDITIONS

1. All resellers must have approved and signed Reseller Application on file including their respective state tax information and W-9. Applications are re-evaluated on a fiscal calendar year basis to assure business integrity and tax status.
2. Cash, check, cashiers check, ACH, wire transfer, MasterCard, Visa, Discover and American Express are accepted forms of payment.
3. Past due invoices will be charged 1.5% per month finance charge. Uncollected invoices are subject to be turned over to collection.
4. The reseller will pay all reasonable expenses incurred in the course of collections.
5. The proper venue for litigation will be Bexar County, Texas.
6. Returned checks will be charged a \$50.00 fee.
7. All prices are in U.S. Dollars.
8. All prices and specifications are subject to change without notice, sales order confirmations are emailed and will reflect correct pricing.
9. All terms are insured, monitored, analyzed and approved by Coface USA. Changes in credit line and approved terms can change without notice. Company authorization of credit is based on Coface approvals. Any conflicts or disagreements should be referred to:
650 College Rd. East Suite 2005 Princeton, NJ 08540. 1-609-469-0400. E-mail: cofaceusa@coface.com
10. Returns are subject to 25% restocking charge plus any necessary charges for repair or re-packaging.

SHIPPING TERMS AND CONDITIONS

1. All orders are EXW San Antonio, TX (EXW means that a buyer/reseller incurs the risks for bringing the goods to their final destination). Any deviation needs to be done in writing.
2. UPS ground shipping is the preferred shipping method. Requests for specific carriers may require use of the customer's account number and may incur an additional charge for handling.
3. Drop shipments are subject to all return charges at reseller's expense. Drop shipments are not allowed outside of the territorial United States.
4. No C.O.D. shipments allowed.
5. Returned and undelivered shipment charges are the buyer/reseller's responsibility and will be billed to the buyer/reseller.
6. The freight carrier and company shipping@mega.lighting should be notified upon receipt of damaged freight, discrepancies or non-conformities within 24 hours. Company can assist in making claims with carriers or agents in the event of any loss or damage.

WARRANTY AND SERVICE PROCEDURES

1. All returns require an RMA# (Return Merchandise Authorization number) before returning goods for any reason. For a service or warranty RMA, please email service@mega.lighting or call 210-684-2600. For sales or demo returns, please contact sales@mega.lighting.
2. Case will be created and an RMA notice will be emailed. All units received must have the RMA # included with the unit as well as on the shipping label.
3. All shipping charges are the responsibility of the customer. MEGA Systems, Inc., Service, 18668 HWY 16 N, Helotes, TX 78023.

WARRANTY FOR PRODUCTS PURCHASED BEFORE 2021

Unless otherwise stated in writing, product is covered by a **one year parts and labor** limited warranty and is subject to same limitation listed under the limited warranty exclusions listed below.

WARRANTY FOR PRODUCTS PURCHASED AFTER JANUARY 1, 2021

MEGA SYSTEMS INC ("MSI") hereby warrants to the original purchaser/owner ("Customer"), MSI products to be free of manufacturing defects in material and workmanship, for the warranty periods as defined below from the original purchase invoice date. This warranty applies exclusively to new MSI branded and/or distributed products listed below, purchased from an MSI AUTHORIZED dealer/ reseller. This warranty is not transferable and may or may not apply to products sold and/or forwarded outside the United States. Please contact MSI for applicable regional product warranty information. The purchase of MSI product constitutes the Customer's acceptance of all warranty terms and conditions as listed in this limited warranty statement. This warranty provides the Customer with legal rights which may vary from state to state. Please contact MSI regarding warranty questions prior to purchasing.

Product / Series	Warranty Period	Coverage
BATTERY POWERED LED	Six month battery one year all other components	1, 2
MOVING LED, HAZERS	One year	2
OUTDOOR IP RATED LED	Two Year	3
HOUSE LIGHT LED, DECORATIVE LED, COMPACT LED, ICANDY LED, THEATRICAL LED, STROBE WASH LED, FOLLOW SPOT LED, PRODUCTION & HOUSE OF WORSHIP CONTROL, ARCHITECTURAL CONTROL, THEATRICAL CONTROL, DANCE VENUE & MOBILE DJ CONTROL, DIRECT VIEW LED DISPLAYS, AND MV CONTROLS	Three Year	4

1. Battery, 183 days six months 2. Parts and Labor, 365 days one year 3. Parts and Labor, 730 days two year 4. Parts and Labor, 1095 days three year

This limited warranty excludes any defects caused by, resulting from or relating to the following:

- Normal wear and tear of lamps, color media, brushes, contact rings, lamp sockets, belts and other parts prone to wear and tear.
- Misuse, abuse, improper handling, accident, alteration or attempts to repair by or on behalf of the owner or any person not authorized by MSI.
- Damage to the product resulting from acts of God, including, but not limited to, earthquakes, hurricanes, tornados, lightning and other natural disasters, fire, explosion, flood, riots, civil disorder or any other cause beyond the reasonable control of MSI.
- Exposure to harsh or excessively corrosive environmental conditions (whether indoors or outdoors), including, but not limited to, extreme temperatures, humidity, atmospheric conditions (including salinity or pressure), radiation (UV, infrared or nuclear), shock and conditions which exceed the product's Ingress Protection ("IP") rating.
- Use of the product in a manner which exceeds the applicable product specification, including, but not limited to, exposure to excessive, insufficient or other voltage conditions.
- Installation or use of the product not in accordance with the technical documentation, MSI guidelines (as may be posted on its website at www.megasystemsinc.com from time to time or otherwise designated by MSI or its brands) or applicable building and electrical codes, regulations and standards.
- Failure to maintain the product in accordance with the technical documentation.
- Natural degradation and color shift of the LED source over the course of normal product use.
- Slight deviations in the specified values of intensity and color that do not affect the functionality of the product.
- Use of the product not for its intended purpose.

All warranty claims are evaluated under the terms of this limited warranty. If a product falls within the warranty period and if, upon examination by MSI it is found to have failed for a covered cause, MSI will, at its sole discretion, repair or replace the defective part or product or reimburse the purchaser a pro-rated portion of the purchase price based on the percentage of the warranty period still remaining as of the date that the returned product was received by MSI. Should a replacement part or product be discontinued or unavailable, MSI reserves the right, in its sole and absolute discretion, to substitute a comparable replacement part or product for the defective part or product. MSI warranty obligation hereunder is limited solely to the repair or replacement of or reimbursement for the particular parts or products determined by MSI to have failed for a covered cause within the warranty period. In no event shall MSI be responsible to replace or reimburse purchaser for any products or portions of a system that MSI determines has not failed for a covered cause within the warranty period, even if such other products or portions of a system are used together with products being repaired or replaced by MSI under this warranty and the repaired product differs in brightness, colors or any other attribute after the repair.

Costs of removal, shipping to MSI or its authorized representative and reinstallation are solely the responsibility of the purchaser. If MSI determines that the product is covered by this limited warranty, it will only pay for parts and labor as indicated by product type. If MSI determines that the product is not covered by this limited warranty, the purchaser will have the option of paying for the repair (if the product can be repaired) and the purchaser shall be responsible for the cost of shipping the repaired product back to the purchaser. MSI reserves the right, in its sole and absolute discretion, to decline any repair.

IN NO EVENT SHALL MEGA SYSTEMS, INC. BE LIABLE FOR ANY INCIDENTAL, CONSEQUENTIAL, SPECIAL, INDIRECT OR PUNITIVE LOSS OR DAMAGE OF ANY KIND, INCLUDING, BUT NOT LIMITED TO, LOSS OF PROFITS OR REVENUES, LOSS OF USE OF THE PRODUCT OR ANY OTHER GOODS OR ASSOCIATED EQUIPMENT, DAMAGE TO ANY ASSOCIATED EQUIPMENT, COST OF CAPITAL, COST OF SUBSTITUTE PRODUCTS, FACILITIES OR SERVICES, DOWN TIME COST, INSTALLATION OR LABOR COSTS, OR CLAIMS OF THE PURCHASER'S CUSTOMERS, WHETHER BASED ON WARRANTY, CONTRACT OR NEGLIGENCE, ARISING IN CONNECTION WITH THE SALE, USE OR REPAIR OF THE PRODUCT. MEGA SYSTEMS INC'S MAXIMUM LIABILITY SHALL NOT, IN ANY CASE, EXCEED THE PURCHASE PRICE OF THE PRODUCT THAT GIVES RISE TO THE CLAIM.

EXCEPT FOR THE LIMITED WARRANTY SET FORTH HEREIN, ALL PRODUCTS SOLD BY MEGA SYSTEMS, INC. ARE SOLD "AS IS" WITHOUT ANY WARRANTY, EXPRESS OR IMPLIED, STATUTORY OR OTHERWISE, INCLUDING, BUT NOT LIMITED TO, IMPLIED WARRANTIES OF MERCHANTABILITY AND FITNESS FOR A PARTICULAR PURPOSE, ALL OF WHICH ARE EXPRESSLY AND SPECIFICALLY DISCLAIMED BY MEGA SYSTEMS, INC.

Customer Support

MEGA Lite has a customer support line to provide set-up help and to answer any questions should you encounter a problem. Please visit our website for any other related technical documents. For service related issues, please contact our service dept.

Monday - Friday 9am to 6pm CST
(210) 684-2600
service@mega.lighting

Manual Version

Please visit www.mega.lighting for the most up-to-date manual version.

Manual Version	Date	Fixture Software	Notes
1.0	11/02/2024	V1.0	



MEGA LITE
18662 Bandera Rd
Helotes, TX 78023
Phone (210)684-2600 / Fax (210)855-6279
www.mega.lighting / info@mega.lighting